

TurnLine

**BOREMEISTER**

www.tungaloy.com

Tungaloy Report No. 517-G



## Vibration-Free Solution for Deep-Hole Boring

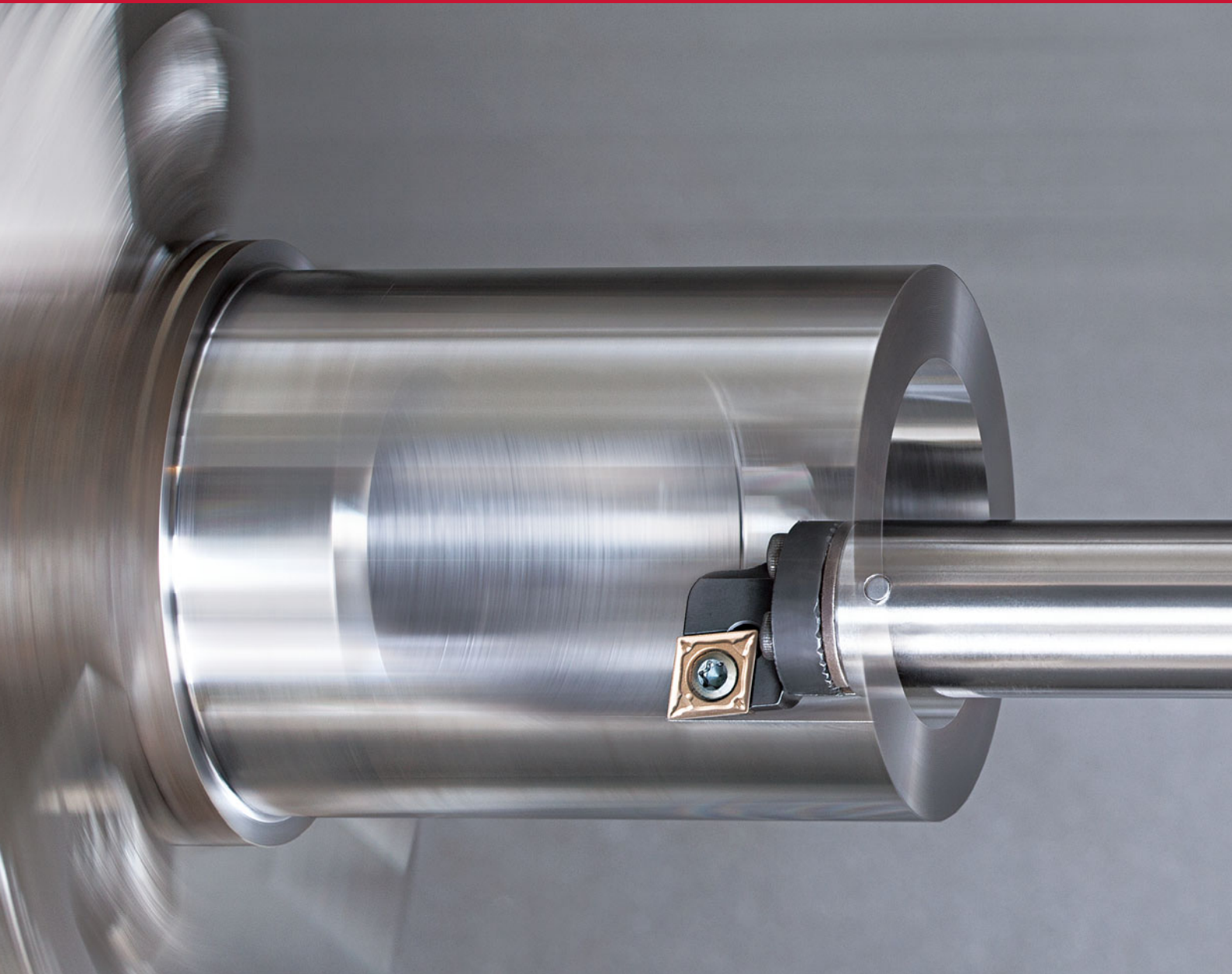

**INDUSTRY 4.0**  
*FEED the SPEED!*



ACCELERATED MACHINING



TurnLine

**BOREMEISTER**

TUNGALOY ANTI-VIBRATION TURNING



Ultimate solution for overcoming tool overhang challenges of up to  $L/D = 10$

[www.tungaloy.com](http://www.tungaloy.com)



Unique anti-vibration mechanism in the tool body reduces vibration during deep hole boring with long overhangs of up to **L/D = 10**

- Minimum bore diameter :  $\varnothing 20$  mm
- Internal coolant supply improves chip evacuation during deep hole machining
- Various types of cutting heads are available to accommodate different insert shapes

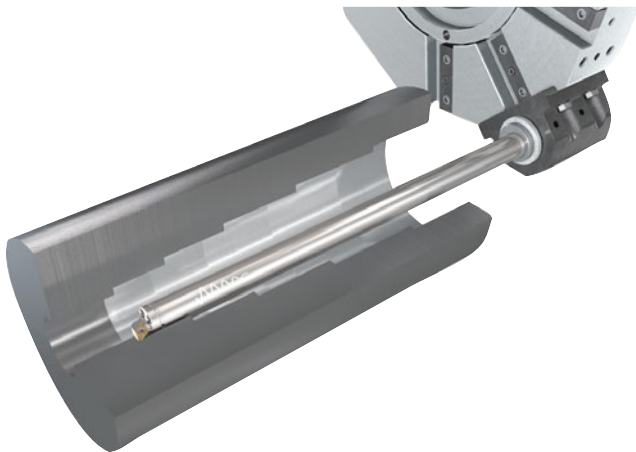

## Vibration Dampening Mechanism

When cutting forces create vibration on boring bar set up with long overhangs, the bar's dampening mechanism counters the tool's motion and cancels the vibration.

The dampening mechanism consists of a weight supported by spring elements.

The vibrations die out quickly eliminating noise and chatter marks.

### - Concept image of dampening mechanism

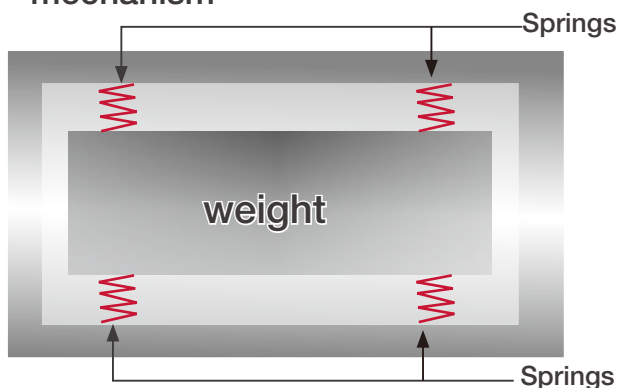

### - Tool vibrations with and without vibration damper

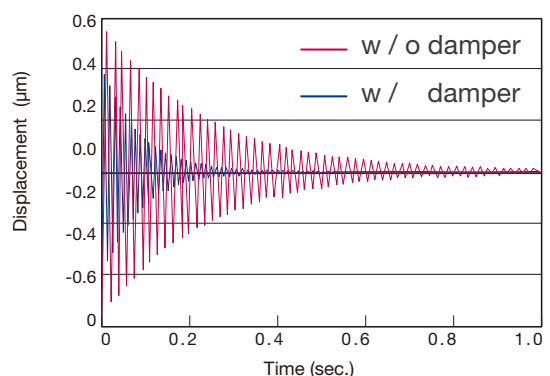

## Standard Lineup

### BoreMeister anti-vibration bars

L/D	Shank diameter (mm)						
	ø16	ø20	ø25	ø32	ø40	ø50	ø60
7	○	○	○	○	△	△	△
10	●	●	○	○	△	△	△

○ : steel shank

● : carbide shank

△ : on demand

### BoreMeister head

Insert shape	Shank diameter (mm)				
	ø16	ø20	ø25	ø32	ø40, ø50, ø60
CCMT	○	○	○	○	△
DCMT	○	○	○	○	△
VCMT		○	○	△	△
DNMG				△	△
VNMG					△

○ : standard

△ : on demand

BoreMeister is comprised of the anti-vibration bar and interchangeable boring head, featuring serrated interfaces for high precision indexing. They are connected by screws, allowing the fitting of a wide range of cutting heads for great flexibility.

Anti vibration bar

Boring head

Serration

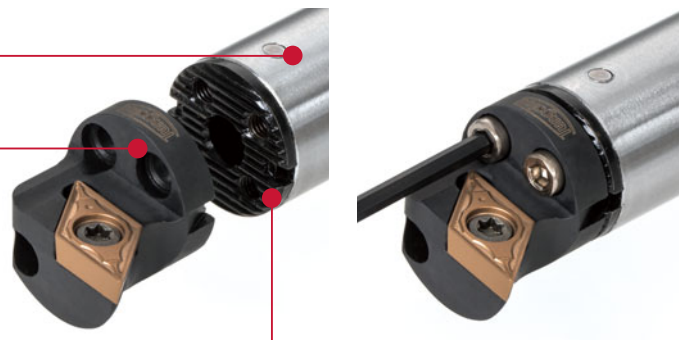

## Boring bar selection guide

For machining of long overhangs of over  $5xL/D$ , the use of an anti-vibration bar is effective.

### Tool selection according to length-to-diameter ratio

Steel shank	Carbide reinforced	Carbide shank	BoreMeister
$L/D \leq 3$	$L/D \leq 4$	$L/D \leq 5$	$L/D \leq 10$

For custom tooling inquiries, contact Tungaloy



## General use recommendations

### 1. Machine clamping recommendation

Clamping stability is extremely important for BoreMeister to maximize its vibration dampening capability. When clamping the cylindrical boring bar, Tungaloy recommends the use of split sleeve holders, which encompasses the tool shank to secure maximum contact area. Never use a conventional screw clamp method as it may damage the tool and will not properly prevent vibration.

#### Clamping method

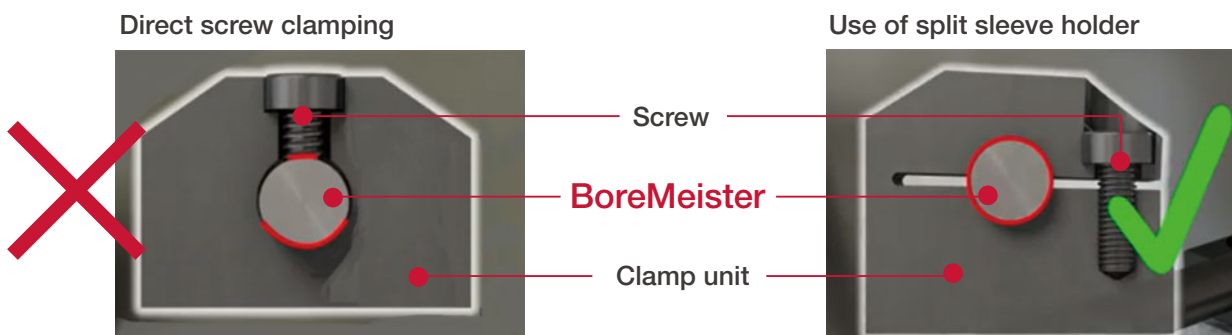

For custom tooling inquiries, contact Tungaloy.

Clamping length of BoreMeister should be  $L/D = 4$  or more.

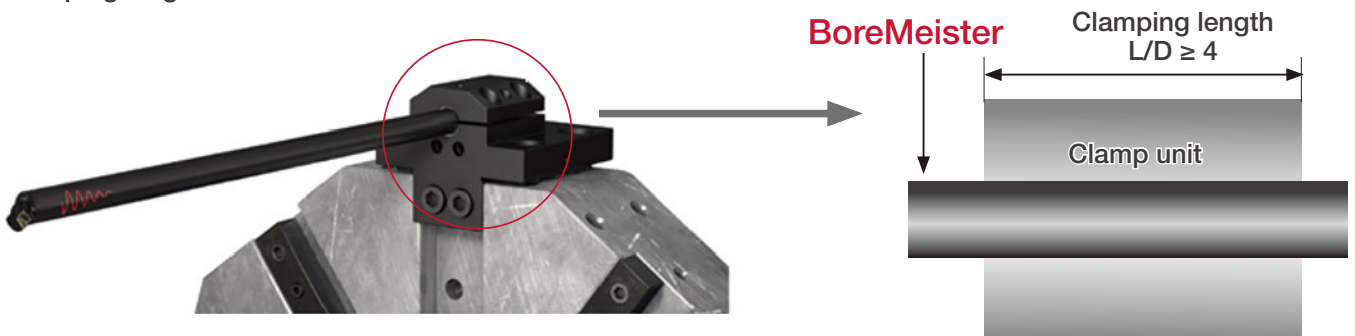

### 2. Center height positioning

Precise center height positioning is another important factor to achieve the right dimension tolerances and surface finish. BoreMeister has no flats on its cylindrical shank to secure the tool center. Use a dial gauge to properly adjust the tool center height while fine-sliding the boring head on the serrated interface.

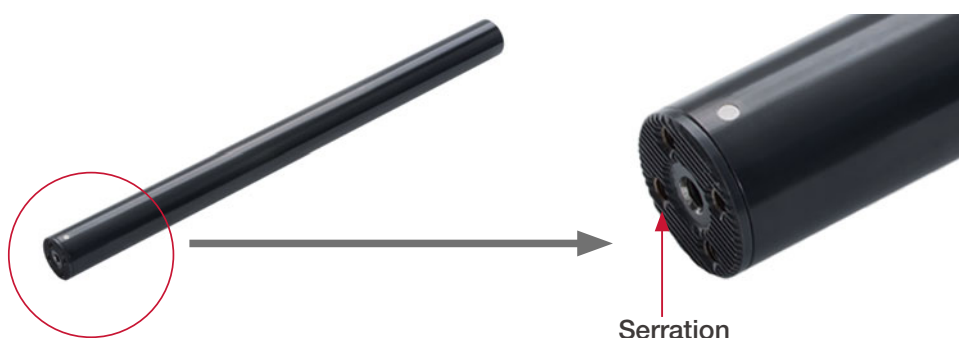

## S-SCLCR/L-H

Screw-on clamp interchangeable boring heads for positive 80° rhombic inserts

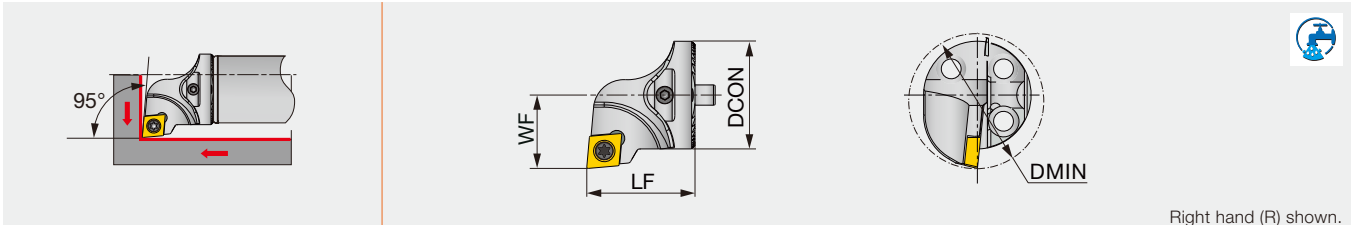

Right hand (R) shown.

Designation	DMIN	DCON	WF	LF	Shank size	Insert
S16-SCLCR/L06-H	20	16	11	20	D16	CC**0602...
S20-SCLCR/L09-H	25	20	13	20	D20	CC**09T3...
S25-SCLCR/L09-H	32	25	17	22	D25	CC**09T3...
S32-SCLCR/L09-H	40	30	22	32	D32	CC**09T3...
S40-SCLCR/L12T-H	50	40	27	38	D40, D50, D60	CC**1204...

Note: When using a right or left hand insert, the right hand insert (R) is used for the left hand toolholders (SCLCL\*\* type), and the left hand insert (L) is used for the right hand toolholders (SCLCR\*\* type).

### SPARE PARTS



Designation	Clamping screw	Wrench	Shim	Shim screw
S16-SCLCR/L06-H	SR14-548	T-7/5	-	-
S20-SCLCR/L09-H	SR16-236	T-15/5	-	-
S25-SCLCR/L09-H	SR16-236	T-15/5	-	-
S32-SCLCR/L09-H	SR16-236	T-15/5	-	-
S40-SCLCR/L12T-H	SR16-212	T-20/5	TCC4-2	SRTC-4



## S-SDUCR/L-H

Screw-on clamp interchangeable boring heads for positive 55° rhombic inserts

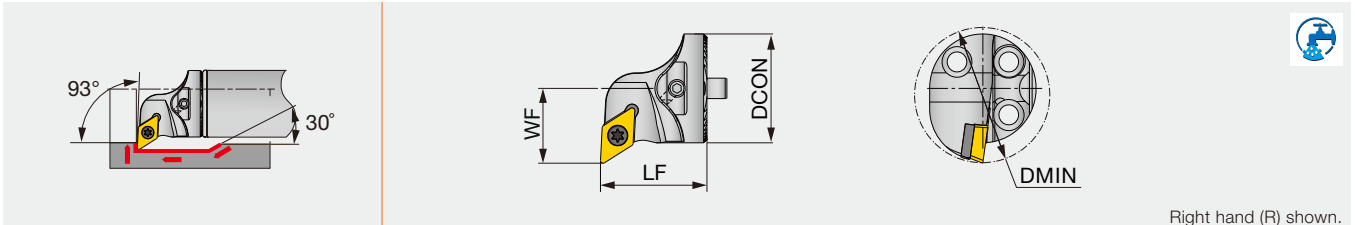

Right hand (R) shown.

Designation	DMIN	DCON	WF	LF	Shank size	Insert
S16-SDUCR/L07-H	20	16	11	20	D16	DC**0702...
S20-SDUCR/L11-H	25	20	13	20	D20	DC**11T3...
S25-SDUCR/L11-H	32	25	17	22	D25	DC**11T3...
S32-SDUCR/L11T-H	40	30	22	32	D32	DC**11T3...
S40-SDUCR/L11T-H	50	40	27	38	D40, D50, D60	DC**11T3...

Note: When using a right or left hand insert, the right hand insert (R) is used for the left hand toolholders (SDUCL\*\* type), and the left hand insert (L) is used for the right hand toolholders (SDUCR\*\* type).

### SPARE PARTS



Designation	Clamping screw	Wrench	Shim	Shim screw
S16-SDUCR/L07-H	SR14-548	T-7/5	-	-
S20-SDUCR/L11-H	SR16-236P	T-15/5	-	-
S25-SDUCR/L11-H	SR16-236P	T-15/5	-	-
S32-SDUCR/L11T-H	SR16-236P	T-15/5	TDC3-1P	SRTC-3P
S40-SDUCR/L11T-H	SR16-236P	T-15/5	TDC3-1P	SRTC-3P

## S-SVUCR/L-H

Screw-on clamp interchangeable boring heads for positive 35° rhombic inserts

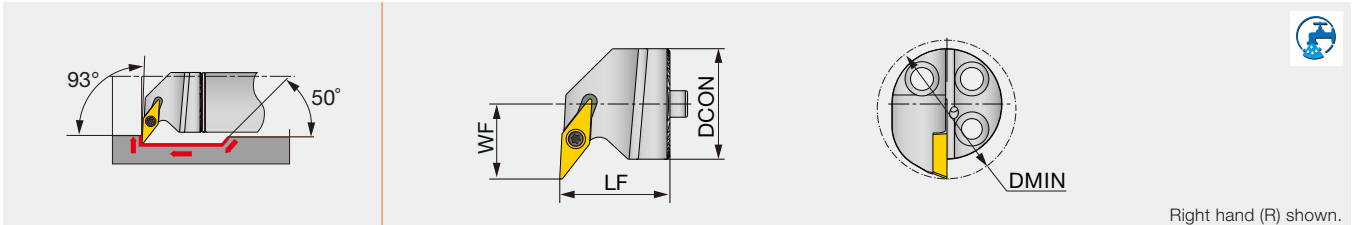

Right hand (R) shown.

Designation	DMIN	DCON	WF	LF	Shank size	Insert
S20-SVUCR/L11-H	27	20	16	20	D20	VC**1103...
S25-SVUCR/L11-H	31	25	17	25	D25	VC**1103...

Note: When using a right or left hand insert, the right hand insert (R) is used for the left hand toolholders (SVUCL\*\* type), and the left hand insert (L) is used for the right hand toolholders (SVUCR\*\* type).

### SPARE PARTS



Designation	Clamping screw	Wrench
S20-SVUCR/L11-H	SR14-560	T-8/5
S25-SVUCR/L11-H	SR14-560	T-8/5

## S-SVLCR/L-H

Screw-on clamp interchangeable boring heads for positive 35° rhombic inserts

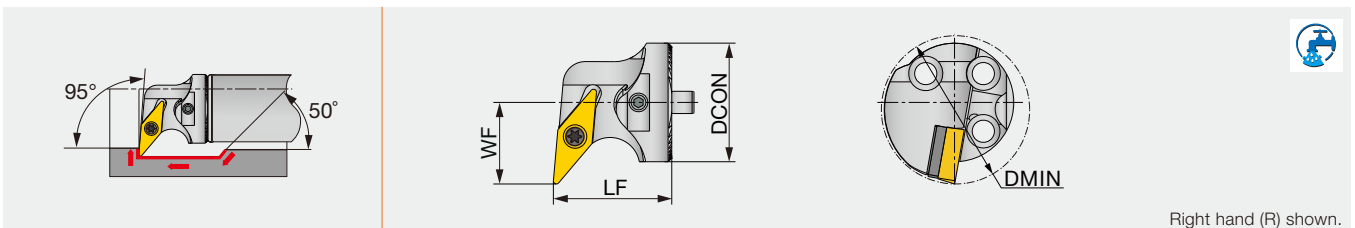

Right hand (R) shown.

Designation	DMIN	DCON	WF	LF	Shank size	Insert
S32-SVLCR/L16T-H	40	32	22	32	D32	VC**1604...
S40-SVLCR/L16T-H	50	40	27	32	D40, D50, D60	VC**1604...

Note: When using a right or left hand insert, the right hand insert (R) is used for the left hand toolholders (SVLCL\*\* type), and the left hand insert (L) is used for the right hand toolholders (SVLCR\*\* type).

### SPARE PARTS



Designation	Clamping screw	Wrench	Shim	Shim screw
S32-SVLCR/L16T-H	SR16-236P	T-15/5	TVC 3-1P	SRTC-3P
S40-SVLCR/L16T-H	SR16-236P	T-15/5	TVC 3-1P	SRTC-3P

## S-DDUNR/L-H

Double clamp interchangeable boring heads for negative 55° rhombic inserts

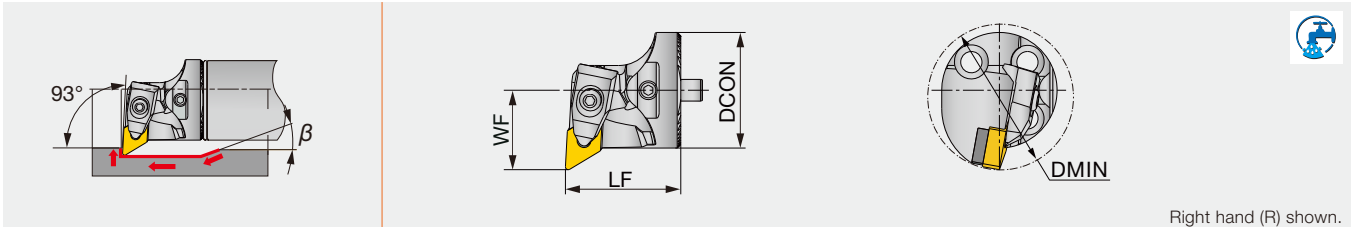

Right hand (R) shown.

Designation	DMIN	DCON	WF	LF	Shank size	Insert
S32-DDUNR/L11T-H	40	32	22	32	D32	DN**1104...
S40-DDUNR/L15T-H	50	40	27	32	D40, D50, D60	DN**1504/06...

Note: When using a right or left hand insert, the right hand insert (R) is used for the left hand toolholders (DDUNL\*\* type), and the left hand insert (L) is used for the right hand toolholders (DDUNR\*\* type).

### SPARE PARTS

Designation	Shim	Shim screw	Clamp	Clamping screw	Spring	Wrench
S32-DDUNR/L11T-H	RDT3-2	SR40085I	LCGR-3	SRRC3	KSP3	HW2.5
S40-DDUNR/L15T-H	RDT433	SR14-506	DLM4	DLS4	DSP4	HW3.0
S40-DDUNR/L15T-H	RDT443	SR14-506	DLM4	DLS4	DSP4	HW3.0

## S-DVUNR/L-H

Double clamp interchangeable boring heads for negative 35° rhombic inserts

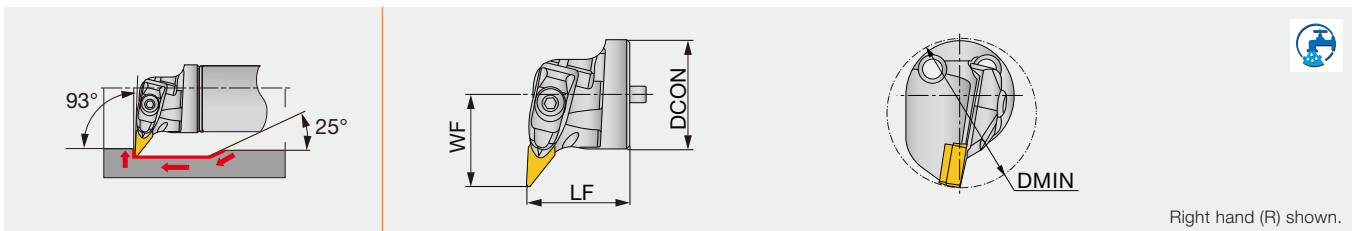

Right hand (R) shown.

Designation	DMIN	DCON	WF	LF	Shank size	Insert
S40-DVUNR/L16T-H	52	40	30	36	D40, D50, D60	VN**1604...

### SPARE PARTS

Designation	Shim	Shim screw	Clamp	Clamping screw	Spring	Wrench
S40-DVUNR/L16T-H	ASV322	SR35080I	DLM3V	SR10402267	KSP5	HW4.0

## Straight Shank

Anti-vibration bars with through coolant for interchangeable turning heads

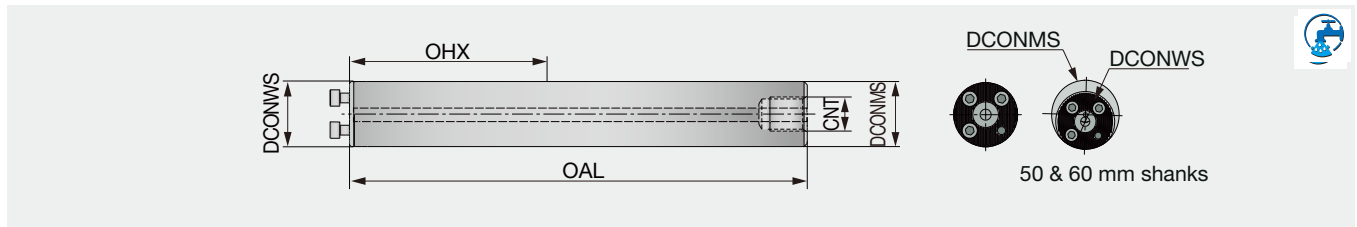

Designation	Material	DCONWS	DCONMS	OAL	OHX	CNT
D16-L156-7D-C	Steel	16	16	156	92	G1/8
G16-L204-10D-E	Carbide	16	16	204	140	-
D20-L200-7D-C	Steel	20	20	200	120	G1/4
G20-L260-10D-E	Carbide	20	20	260	180	-
D25-L255-7D-C	Steel	25	25	255	155	G1/4
D25-L330-10D-C	Steel	25	25	330	230	G1/4
D32-L320-7D-C	Steel	32	32	320	192	G3/8
D32-L416-10D-C	Steel	32	32	416	288	G3/8
D40-L408-7D-C	Steel	40	40	408	248	G1/2
D40-L528-10D-C	Steel	40	40	528	368	G1/2
D50-L518-7D-C	Steel	40	50	518	318	G1/2
D50-L668-10D-C	Steel	40	50	668	468	G1/2
D60-L628-7D-C	Steel	40	60	628	388	G3/4
D60-L808-10D-C	Steel	40	60	808	568	G3/4

### SPARE PARTS



Designation	Clamping screw	Wrench
D16-L..., G16-L...	SRM3X10DIN912	HW2.5
D20-L..., G20-L...	SRM3.5X10DIN912	HW2.5
D25-L...	SRM4X12DIN912	HW3.0
D32-L...	SRM5X12DIN912	HW4.0
D40-L..., D50-L..., D60-L...	SRM6X16DIN912-12.9	HW5.0





# MEMO

A large grid of graph paper for taking notes, consisting of 20 columns and 30 rows of small squares.

# Check our site and our App to get more info!

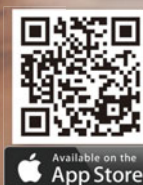
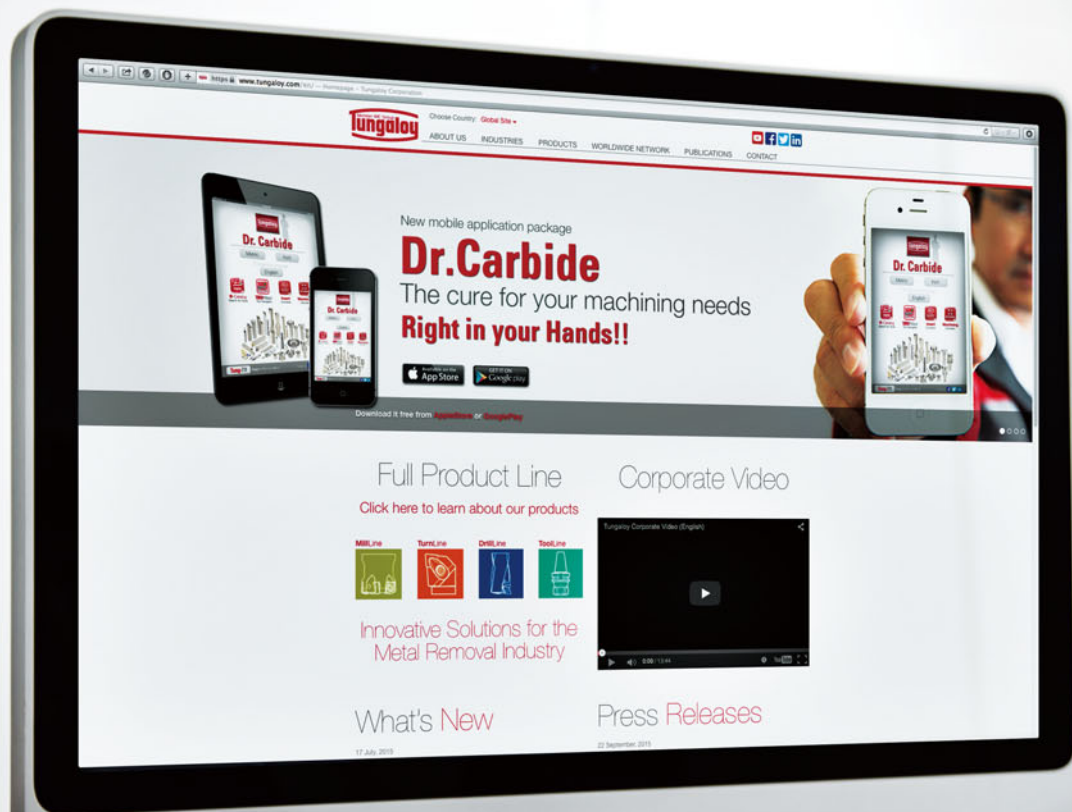

Available on the App Store

GET IT ON Google play

## Tungaloy Corporation (Head office)

11-1 Yoshima-Kogyodanchi  
Iwaki-city, Fukushima, 970-1144 Japan  
Phone: +81-246-36-8501  
Fax: +81-246-36-8542  
www.tungaloy.co.jp

## Tungaloy America, Inc.

3726 N Ventura Drive  
Arlington Heights, IL 60004, U.S.A.  
Phone: +1-888-554-8394  
Fax: +1-888-554-8392  
www.tungaloyamerica.com

## Tungaloy Canada

432 Elgin St. Unit 3  
Brantford, Ontario N3S 7P7, Canada  
Phone: +1-519-758-5779  
Fax: +1-519-758-5791  
www.tungaloy.com/ca

## Tungaloy de Mexico S.A.

C Los Arellano 113,  
Parque Industrial Siglo XXI  
Aguascalientes, AGS, Mexico 20290  
Phone: +52-449-929-5410  
Fax: +52-449-929-5411  
www.tungaloy.com/mx

## Tungaloy do Brasil Ltda.

Avd. Independencia N4158 Residencial Flora  
13280-000 Vinhedo, São Paulo, Brasil  
Phone: +55-19-38262757  
Fax: +55-19-38262757  
www.tungaloy.com/br

## Tungaloy Germany GmbH

An der Alten Ziegelei 1  
D-40789 Monheim, Germany  
Phone: +49-2173-90420-0  
Fax: +49-2173-90420-19  
www.tungaloy.de

## Tungaloy France S.A.S.

ZA Courtaboeuf - Le Rio  
1 rue de la Terre de feu  
F-91952 Courtaboeuf Cedex, France  
Phone: +33-1-6486-4300  
Fax: +33-1-6907-7817  
www.tungaloy.fr

## Tungaloy Italia S.r.l.

Via E. Andolfato 10  
I-20126 Milano, Italy  
Phone: +39-02-252012-1  
Fax: +39-02-252012-65  
www.tungaloy.it

## Tungaloy Czech s.r.o.

Turanka 115  
CZ-627 00 Brno, Czech Republic  
Phone: +420-532 123 391  
Fax: +420-532 123 392  
www.tungaloy.cz

## Tungaloy Ibérica S.L.

C/Miquel Servet, 43B, Nau 7  
Pol. Ind. Bufalvent  
ES-08243 Manresa (BCN), Spain  
Phone: +34 93 113 1360  
Fax: +34 93 876 2798  
www.tungaloy.es

## Tungaloy Scandinavia AB

Bultgatan 38  
442 40 Kungälv, Sweden  
Phone: +46-462119200  
www.tungaloy.se

## Tungaloy Rus, LLC

115432, Moscow, Andropov Avenue, 18,  
building 7, 11th floor (office 3). Metro station  
"Technopark". Business center «I-Land».  
Phone: +7-499-683-01-80/81  
www.tungaloy.com/ru

## Tungaloy Polska Sp. z o.o.

ul. Genewska 24  
03-963 Warszawa, Poland  
Phone: +48-22-617-0890  
Fax: +48-22-617-0890  
www.tungaloy.com/pl

## Tungaloy U.K. Ltd

The Technology Centre,  
Wolverhampton Science Park  
Glaisher Drive, Wolverhampton  
West Midlands WV10 9RU, UK  
Phone: +44 121 4000 231  
Fax: +44 121 270 9694  
www.tungaloy.com/uk  
salesinfo@tungaloyuk.co.uk

## Tungaloy Hungary Kft

Erzsébet királyné útja 125  
H-1142 Budapest, Hungary  
Phone: +36 1 781-6846  
Fax: +36 1 781-6866  
www.tungaloy.com/hu  
info@tungaloytools.hu

## Tungaloy Turkey

Dudullu OSB 4. Cad No:4  
34776 Umraniye Istanbul, TURKEY  
Phone: +90 216 540 04 67  
Fax: +90 216 540 04 87  
www.tungaloy.com.tr  
info@tungaloy.com.tr

## Tungaloy Benelux b.v.

Tjalk 70  
NL-2411 NZ Bodegraven, Netherlands  
Phone: +31 172 630 420  
Fax: +31 172 630 429  
www.tungaloy-benelux.com

## Tungaloy Croatia

Ulica bana Josipa Jelačića 87,  
10430 Samobor  
Phone: +385 1 3326 604  
Fax: +385 1 3327 683  
www.tungaloy.hr

## Tungaloy Cutting Tool (Shanghai) Co.,Ltd.

Rm No 401 No.88 Zhabei  
Jiangchang No.3 Rd  
Shanghai 200436, China  
Phone: +86-21-3632-1880  
Fax: +86-21-3621-1918  
www.tungaloy.com/cn

## Tungaloy Cutting Tool (Thailand) Co.,Ltd.

Interlink tower 4th Fl.  
1858/5-7 Bangna-Trad Road  
km.5 Bangna, Bangna, Bangkok 10260  
Thailand  
Phone: +66-2-751-5711  
Fax: +66-2-751-5715  
www.tungaloy.co.th

## Tungaloy Singapore (Pte.), Ltd.

62 Ubi Road 1, #06-11 Oxley BizHub 2  
Singapore 408734  
Phone: +65-6391-1833  
Fax: +65-6299-4557  
www.tungaloy.com/sg

## Tungaloy Vietnam

LE 04-38, Lexington Residence  
67 Mai Chi Tho, Dist. 2,  
Ho Chi Minh City, Vietnam  
Phone: +84-8-37406660  
Fax: +84-8-37406662  
www.tungaloy.com/sg

## Tungaloy India Pvt. Ltd.

Indiabulls Finance Centre,  
Unit # 902-A, 9th Floor,  
Tower 1, Senapati Bapat Marg,  
Elphinstone Road (West),  
Mumbai-400013, India  
Phone: +91-22-6124-8804  
Fax: +91-22-6124-8899  
www.tungaloy.com/in

## Tungaloy Korea Co., Ltd

#1312, Byucksan Digital Valley 5-cha  
Beotkkot-ro 244, Geumcheon-gu  
153-788 Seoul, Korea  
Phone: +82-2-2621-6161  
Fax: +82-2-6393-8952  
www.tungaloy.com/kr

## Tungaloy Malaysia Sdn Bhd

50 K-2, Kelana Mall, Jalan SS6/14  
Kelana Jaya, 47301  
Petaling Jaya, Selangor Darul Ehsan  
Malaysia  
Phone: +603-7805-3222  
Fax: +603-7804-8563  
www.tungaloy.com/my

## Tungaloy Australia Pty Ltd

PO Box 2232, 68/1470  
Ferntree Gully Road, Knoxfield  
Victoria 3180, Australia  
Phone: +61-3-9755-8147  
Fax: +61-3-9755-6070  
www.tungaloy.com.au

## PT. Tungaloy Indonesia

Kompleks Grand Wisata Block AA-10 No.3-5  
Cibitung  
Bekasi 17510, Indonesia  
Phone: +62-21-8261-5808  
Fax: +62-21-8261-5809  
www.tungaloy.com/id



www.tungaloy.com

follow us at:

facebook.com/tungaloyjapan

twitter.com/tungaloyjapan

To see this product in action visit:

# Tung-TV

www.youtube.com/tungaloycorporation

Distributed by:



DOWNLOAD  
Dr. Carbide App



FIND US ON THE CLOUD!  
machiningcloud.com



Available on the  
App Store



GET IT ON  
Google play



AS9100 Certified  
78006  
2015.11.04  
ISO14001 Certified  
EC97J1123  
1997.11.26

Produced from Recycled paper

Dec 2018 (TJ)